







Scale 1: 1500

LEGEND

-  SINGLE / SEMI DETACHED
-  PRIVATE GREENWAY (w/ Public Access Easement)
-  REVERSE HOUSING LANE
-  ZEBRA CROSSWALK
-  WALKWAY (3m Sidewalk)
-  SHARED-USE PATH
-  DC1 BOUNDARY

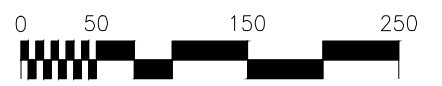
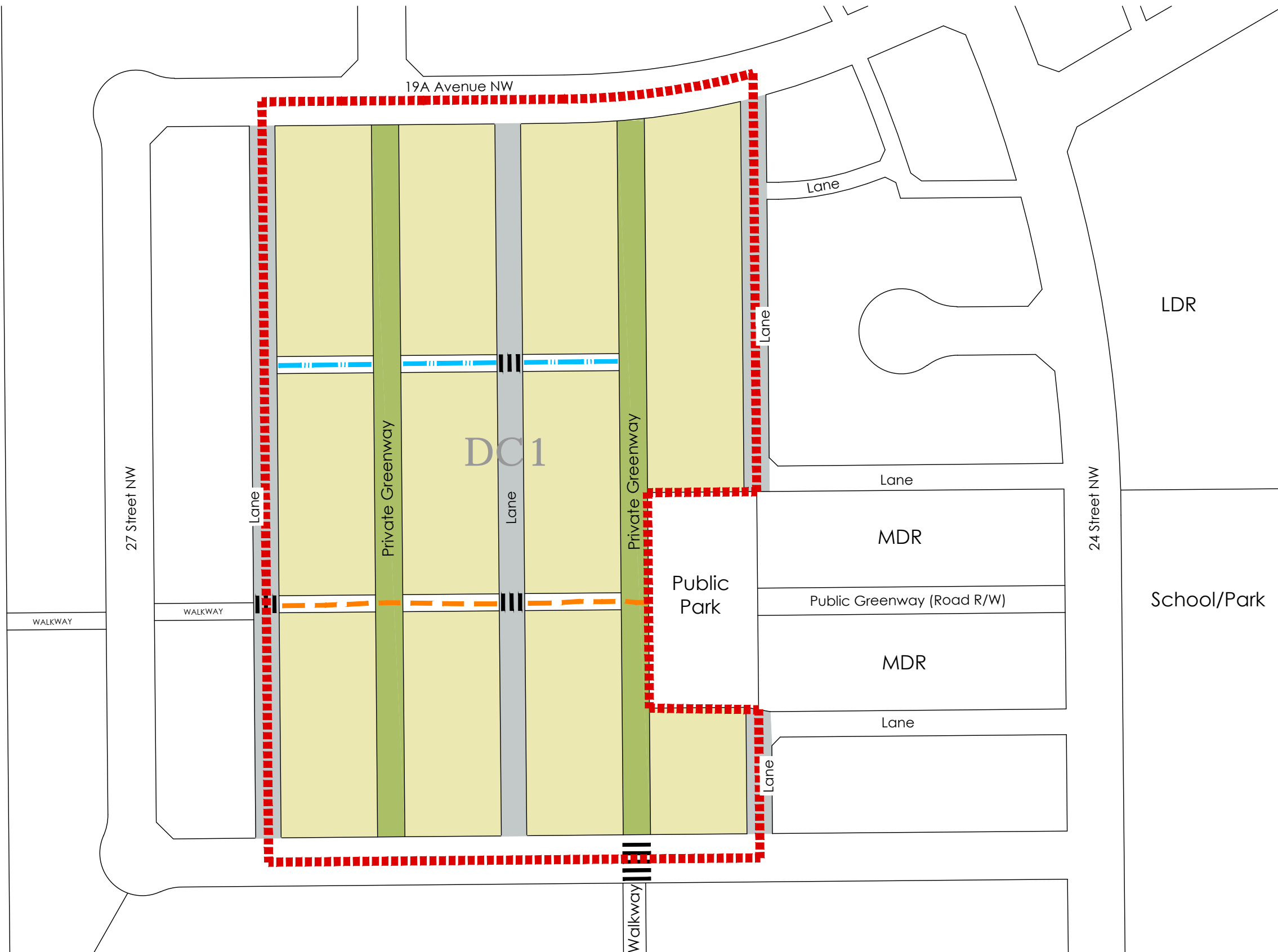

LAUREL EAST REVERSE HOUSING

APPENDIX "A" DC1 AREA

SEPTEMBER 15, 2014- 1161 101465

DREAM DEVELOPMENTS

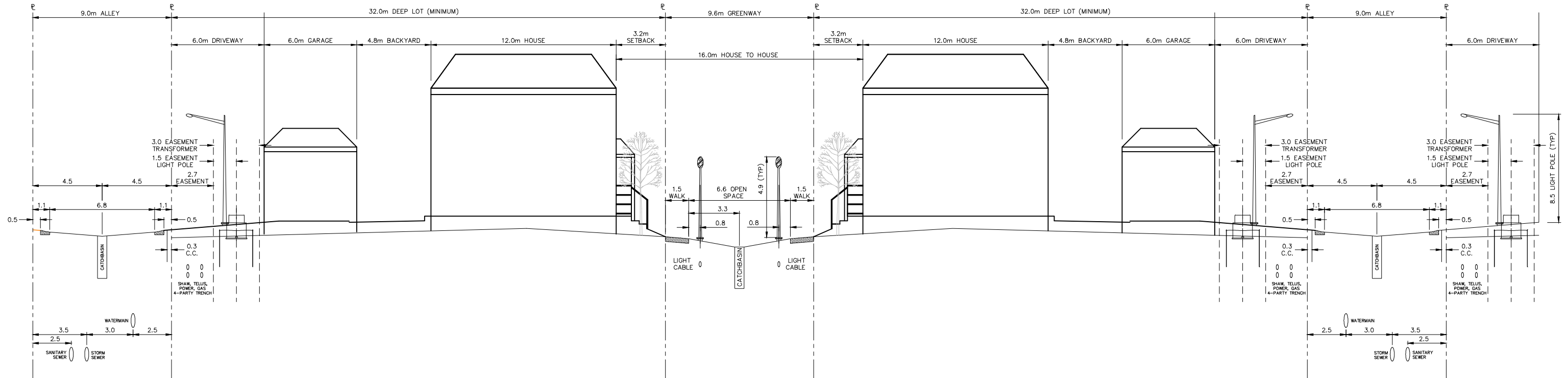

LAUREL EAST GREENWAY HOUSING

APPENDIX "B" Reverse Housing Cross Section

April 1, 2014 - 1161 101465 AM

DUNDEE DEVELOPMENTS LTD

Greenway

9.60m Greenway Cross Section
Property Line to Property Line

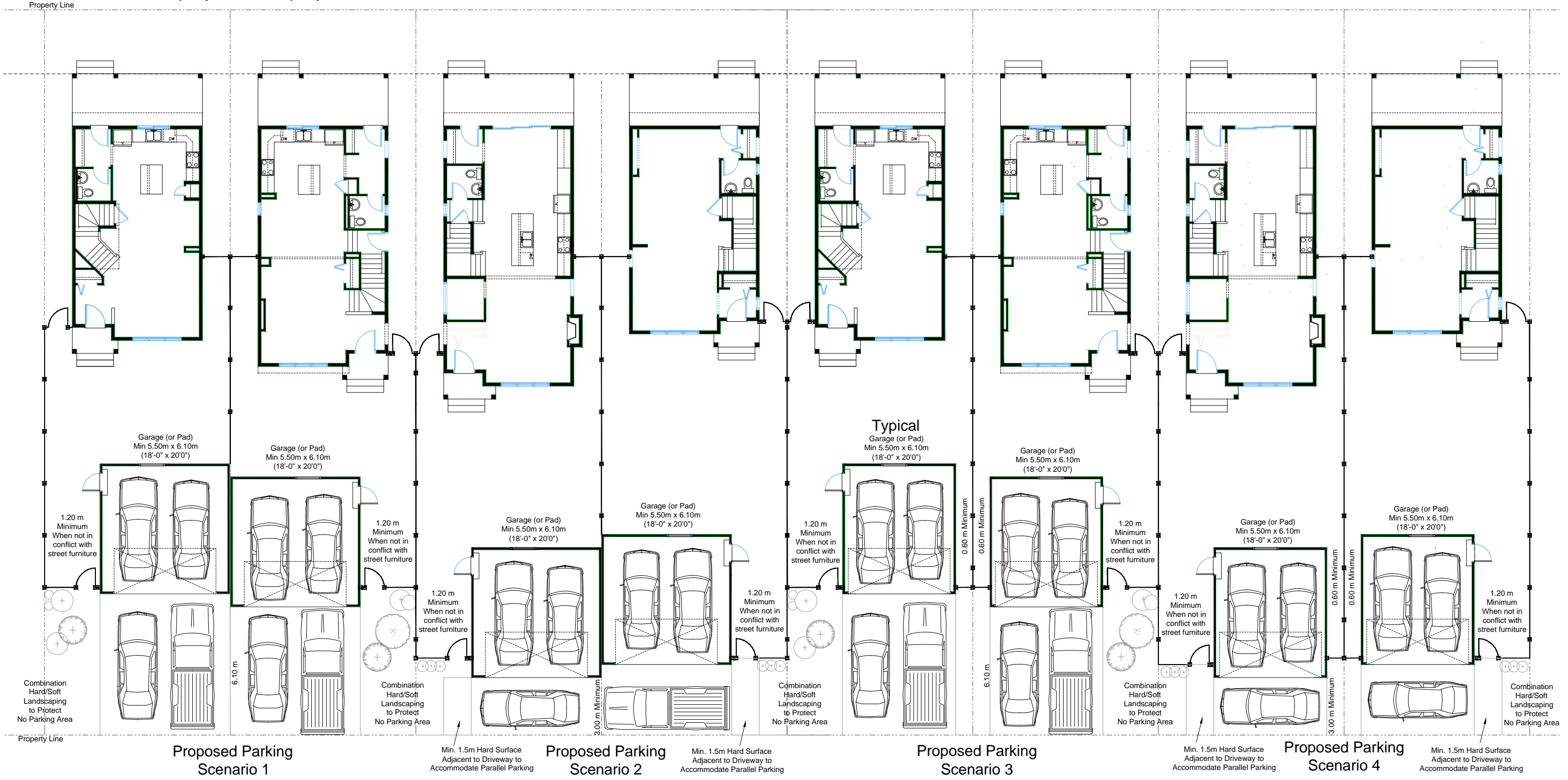

Applicable for
Secondary or
Garage Suite

Lane

Applicable for
Secondary or
Garage Suite